



■ Photo may include optional equipment

We build a better future

HYUNDAI DIESEL FORKLIFT TRUCKS - Applied Tier 3 Engine

50/60/70/80D-7E



Excellent



HMC D4DD engine



Up-to-date cooling system

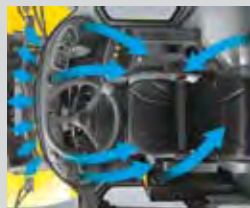

High-output air conditioner

50/60/70/80D -7E

New criteria of forklift trucks

Hyundai introduces a new line of 7E series diesel forklift trucks. Excellent power and performance make your business more profitable.



■ Photo may include optional equipment

The new master on your job-site!

Smooth running, efficient and ergonomically designed, 50/60/70/80D-7E series are made to meet your needs.



Powerful Engine HMC D4DD Engine

Market approved quality of HMC D4DD engine ensures incomparable performance, durability and excellent fuel efficiency. This engine meets EPA Tier-III and EU stage IIIA emission regulations.

73.5 kW / 2,300 rpm
38 kgf.m / 1,600 rpm

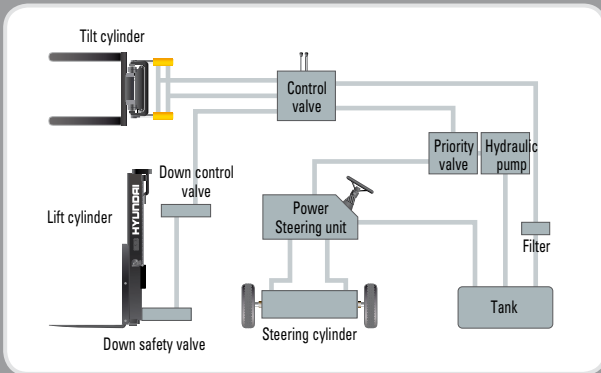

State-of-the-art hydraulic system

The latest large-capacity hydraulic system reacts quickly during operation, and a low-noise control valve increases both efficiency and durability.



Key-locking fuel filler

Increased security on job sites with locking fuel cap, plus an increased capacity fuel tank for less down time.



Wet disc brake system

The wet disc brake system is virtually maintenance free and is enclosed to protect from dust and water.



Full hydrostatic power steering

A hydraulic steering always guarantees smooth and flexible steering, preventing overrun and steering wheel kick-back.



Increased mast tilting angle

The mast tilting angle of 15 degrees forward and 10 degrees backward allows the operator to safely and rapidly perform loading and unloading jobs.



**High Power
Low Noise**

■ Photo may include optional equipment

Faster travel speed & better grade-ability

The powerful high-output engine provides greater acceleration, better gradeability and faster travel speed on any tough terrain or slope.



Grade-ability (Loaded)

50D-7E	48.3 %
60D-7E	41.7 %
70D-7E	37.2 %
80D-7E	32.9 %

Travel speed (Unloaded)

50D-7E	35.1 km/h
60D-7E	34.9 km/h
70D-7E	34.8 km/h
80D-7E	34.5 km/h

Ergonomic operator friendly compartment design!

A design based on human engineering relieves fatigue and increases operator's efficiency.

Operator friendly gauges and water-resistant monitor panel



MP3 CD player

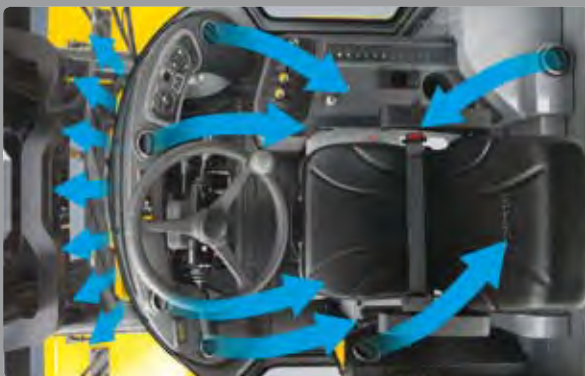

High-output air conditioner & heater

An air conditioner with high-output and heater always provide you a comfortable work environment.



Quick response of operating control levers

Only minimal operator's effort is required for precise, safe and productive control.



Centralized instrument switch panel

Right side switch panel improves operator's convenience.



Adjustable steering wheel

Steering wheel with horn button can be adjusted by a lever on the right-hand side for the most comfortable operator position.



80 mm

40°



■ Photo may include optional equipment



Easy and safe shift lever

A single lever on the left side of the steering column gives the operator fast, easy control of direction. The lever must be in the neutral position before the engine can be started.



Multi-function switch lever

Multi-functional switch lever gives easy access to lights and horn.



Ergonomically positioned pedals

Based on human engineering, the accelerator, brake and inching pedals are optimally positioned for operator's convenience.



Parking brake

Ratchet type parking brake requires less efforts from the operator to set.

Enhanced safety through high durability!

Safety and durability are priorities in the design of the equipment.



Up-to-date cooling system

The minimum fuel consumption and low noise are available by applying hydraulic cooling fan sensing intake air temperature, transmission oil temperature, coolant temperature and hydraulic temperature.



Full-automatic transmission

Full-automatic transmission gives easy, convenient handling and soft, smooth shifting. The operator can select two kinds of automatic mode.



Highly durable split type drive axle

The durable drive axle provides fast travel speed and quiet travel under any heavy load condition, and boosts work efficiency.

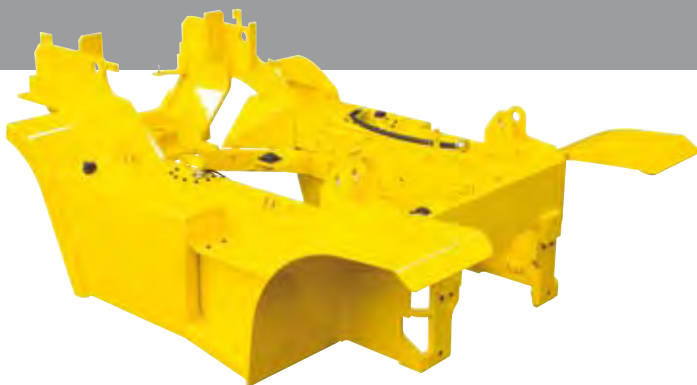

Heavy duty single unit frame

Heavy duty single unit type frame, designed on the basis of accurate structural analysis, guarantees durability and safety.



Large footboard & hand grip

Wide "open" step offers convenience and safety when entering and exiting truck.

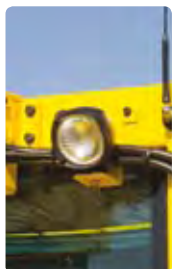

Bright, protected headlights

Bright, protected headlights are positioned for exceptional visibility.





■ Photo may include optional equipment



Expansion bellows

The expansion bellows absorbs vibration and reduces noise generated from the exhaust gas system and extends the life cycle of the exhaust gas system.



Fitted protector for hub bolts

Improved durability by applying a protector to preventing bolts from breaking. (Easy parts supply due to the wheel in common with front wheel)



OPSS (Operator Presence Sensing System)

Mast tilting, lifting and lowering is not possible when the operator is not in the seated position. (Option)



Grease fittings

Grease fittings are installed for fast access to steering axle center pin when performing your service checks.

Centralized design for easy service!

An ideal arrangement of components ensures easy access and convenience during maintenance.



Large engine hood

Highly accessible engine compartment assures fast and efficient maintenance.



Easy change air cleaner

The air filter is readily accessible for cleaning or replacement.



Cabin air fresh filter

The air pressure in the cabin is slightly higher than outside to exclude dust and reduce noise levels.



Cabin tilting automatic system

Cabin tilting automatic system makes servicing of all power train components quick and easy. An electrically assisted hydraulic actuated cylinder tilts operator cabin to left side about 54 degrees for easy access to inside of truck components.



Easy change of Air cleaner

The air-filter is readily accessible for cleaning or replacement.



Electrically monitored air filter

Air cleaner sensor alerts the operator of a clogged air filter and allows replacement before damage.

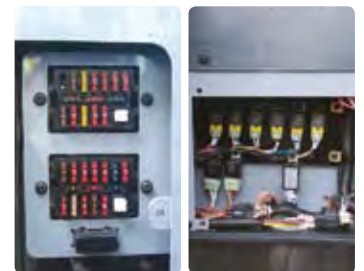

Compact fuse box for easy inspection



■ Photo may include optional equipment



Maintenance free battery



Large tool box

Additional tool box located under footstep for operator's convenience.



Easy-to-access reservoir tank



Wing cover locking system

Mast Specification (Hook/Shaft Type)

Model	Mast Type	Maximum Fork Height (mm)		Overall Height (mm)								Free Lift (mm)				Tilt Angle (deg)		Load Capacity without side shift at 600mm LC (kg)		Load Capacity with side shift at 600mm LC (kg)		Truck Weight (Unloaded) (kg)	
				Lowered		Extended				Without Load Backrest		With Std Load Backrest											
						W/o Load Backrest	W/Std Load Backrest	Hook	Shaft					Hook	Shaft								
Hook	Shaft	Hook	Shaft	Hook	Shaft	Hook	Shaft	Hook	Shaft	Hook	Shaft	Hook	Shaft	Fwd	Bwd	Hook	Shaft	Hook	Shaft	Hook	Shaft		
500-7E	2 Stage limited free lift	V270	2730	2730	2365	2365	3691	-	4020	3975	140	-	140	140	15	10	5000	5000	5000	-	8555	8392	
		*V300	3030	3030	2515	2515	3991	-	4320	4275	140	-	140	140	15	10	5000	5000	5000	-	8602	8439	
		V330	3330	3330	2665	2665	4291	-	4620	4575	140	-	140	140	15	10	5000	5000	5000	-	8650	8487	
		V350	3530	3530	2765	2765	4491	-	4820	4775	140	-	140	140	15	10	5000	5000	5000	-	8682	8519	
		V370	3730	3730	2865	2865	4691	-	5020	4975	140	-	140	140	15	10	5000	5000	5000	-	8714	8550	
		V400	4030	4030	3015	3015	4991	-	5320	5275	140	-	140	140	15	10	5000	5000	5000	-	8770	8606	
		V450	4530	4530	3315	3315	5491	-	5820	5775	140	-	140	140	15	10	5000	5000	5000	-	8997	8834	
		V500	5030	5030	3565	3565	5991	-	6320	6275	140	-	140	140	15	10	5000	5000	5000	-	9077	8914	
		V550	5530	5530	3815	3815	6491	-	6820	6775	140	-	140	140	15	10	5000	5000	5000	-	9156	8993	
		V600	6030	6030	4065	4065	6991	-	7320	7275	140	-	140	140	15	10	5000	5000	4950	-	9235	9072	
3 Stage full free lift	TF450	4560	4560	2565	2565	5545	-	5805	5805	1580	-	1275	1320	15	10	5000	5000	5000	-	9189	9007		
	TF500	5060	5060	2765	2765	6045	-	6305	6305	1780	-	1475	1520	15	10	5000	5000	5000	-	9281	9099		
	TF560	5600	5600	2965	2965	6585	-	6845	6845	1980	-	1675	1720	15	10	5000	5000	4850	-	9392	9210		
	TF600	6060	6060	3165	3165	7045	-	7305	7305	2180	-	1875	1920	15	10	5000	4900	4700	-	9479	9297		

Model	Mast Type	Maximum Fork Height (mm)		Overall Height (mm)								Free Lift (mm)				Tilt Angle (deg)		Load Capacity without side shift at 600mm LC (kg)				Load Capacity with side shift at 600mm LC (kg)				Truck Weight (Unloaded) (kg)			
				Lowered		Extended				Without Load Backrest		With Std Load Backrest		60D-7E				70D-7E		60D-7E		70D-7E		60D-7E		70D-7E			
						W/o Load Backrest	W/Std Load Backrest	Hook	Shaft					Hook	Shaft			Hook	Shaft	Hook	Shaft	Hook	Shaft	Hook	Shaft	Hook	Shaft	Hook	Shaft
Hook	Shaft	Hook	Shaft	Hook	Shaft	Hook	Shaft	Hook	Shaft	Hook	Shaft	Hook	Shaft	Fwd	Bwd	Hook	Shaft	Hook	Shaft	Hook	Shaft	Hook	Shaft	Hook	Shaft	Hook	Shaft	Hook	Shaft
60D-7E / 70D-7E	2 Stage limited free lift	V270	2730	2730	2365	2365	3911	-	4020	3975	140	-	140	140	15	10	6000	6000	7000	7000	6000	-	7000	-	9197	9170	9823	9838	
		*V300	3030	3030	2515	2515	4211	-	4320	4275	140	-	140	140	15	10	6000	6000	7000	7000	6000	-	7000	-	9245	9218	9871	9886	
		V330	3330	3330	2665	2665	4511	-	4620	4575	140	-	140	140	15	10	6000	6000	7000	7000	6000	-	7000	-	9292	9265	9918	9966	
		V350	3530	3530	2765	2765	4711	-	4820	4775	140	-	140	140	15	10	6000	6000	7000	7000	6000	-	7000	-	9324	9297	9950	9965	
		V370	3730	3730	2865	2865	4911	-	5020	4975	140	-	140	140	15	10	6000	6000	7000	7000	6000	-	7000	-	9356	9328	9982	9996	
		V400	4030	4030	3015	3015	5211	-	5320	5275	140	-	140	140	15	10	6000	6000	7000	7000	6000	-	7000	-	9412	9384	10038	10052	
		V450	4530	4530	3315	3315	5711	-	5820	5775	140	-	140	140	15	10	6000	6000	7000	7000	6000	-	7000	-	9640	9612	10266	10280	
		V500	5030	5030	3565	3565	6211	-	6320	6275	140	-	140	140	15	10	6000	6000	7000	7000	5950	-	6850	-	9719	9692	10345	10360	
		V550	5530	5530	3815	3815	6711	-	6820	6775	140	-	140	140	15	10	6000	6000	7000	7000	5750	-	6650	-	9799	9771	10425	10439	
		V600	6030	6030	4065	4065	7211	-	7320	7275	140	-	140	140	15	10	6000	6000	7000	7000	5600	-	6500	-	9877	9850	10503	10518	
3 Stage full free lift	TF450	4560	4560	2565	2565	5765	-	5805	5805	1360	-	1275	1320	15	10	6000	6000	7000	7000	5850	-	6750	-	9848	9808	10474	10476		
	TF500	5060	5060	2765	2765	6265	-	6305	6305	1560	-	1475	1520	15	10	6000	6000	7000	7000	5650	-	6600	-	9940	9900	10566	10568		
	TF560	5600	5600	2965	2965	6805	-	6845	6845	1760	-	1675	1720	15	10	5950	6000	6900	7000	5500	-	6400	-	10051	10011	10677	10679		
	TF600	6060	6060	3165	3165	7265	-	7305	7305	1960	-	1875	1920	15	10	5800	5850	6700	6800	5350	-	6200	-	10139	10098	10765	10766		

Model	Mast Type	Maximum Fork Height (mm)		Overall Height (mm)								Free Lift (mm)				Tilt Angle (deg)		Load Capacity without side shift at 600mm LC (kg)		Load Capacity with side shift at 600mm LC (kg)		Truck Weight (Unloaded) (kg)				
				Lowered		Extended				Without Load Backrest		With Std Load Backrest														
						W/o Load Backrest	W/Std Load Backrest	Hook	Shaft					Hook	Shaft											
Hook	Shaft	Hook	Shaft	Hook	Shaft	Hook	Shaft	Hook	Shaft	Hook	Shaft	Hook	Shaft	Fwd	Bwd	Hook	Shaft	Hook	Shaft	Hook	Shaft	Hook	Shaft			
80D-7E	2 Stage limited free lift	V270	2740	2740	2525	2525	4048	-	4050	4075	150	-	150	150	15	10	8000	8000	8000	8000	8000	-	8000	-	10969	10957
		*V300	3040	3040	2675	2675	4348	-	4350	4375	150	-	150	150	15	10	8000	8000	8000	8000	8000	-	8000	-	11018	11006
		V330	3340	3340	2825	2825	4648	-	4650	4675	150	-	150	150	15	10	8000	8000	8000	8000	8000	-	8000	-	11067	11055
		V350	3540	3540	2925	2925	4848	-	4850	4875	150	-	150	150	15	10	8000	8000	8000	8000	8000	-	8000	-	11100	11088
		V370	3740	3740	3025	3025	5048	-	5050	5075	150	-	150	150	15	10	8000	8000	8000	8000	8000	-	8000	-	11132	11120
		V400	4040	4040	3175	3175	5348	-	5350	5375	150	-	150	150	15	10	8000	8000	8000	8000	8000	-	8000	-	11181	11169
		V450	4540	4540	3475	3475	5848	-	5850	5875	150	-	150	150	15	10	8000	8000	7800	7800	7800	-	7800	-	11396	11384
		V500	5040	5040	3725	3725	6348	-	6350	6375	150	-	150	150	15	10	8000	8000	7600	7600	7600	-	7600	-	11478	11466
		V550	5540	5540	3975	3975	6848	-	6850	6875	150	-	150	150	15	10	7850	7800	7450	7450	7450	-	7450	-	11559	11547
		V600	6040	6040	4225	4225	7348	-	7350	7375	150	-	150	150	15	10	7600	7600	7250	7250	7250	-	7250	-	11641	11629
3 Stage full free lift	TF450	4570	4570	2750	2750	5902	-	5880	5905	1418	-	1440	1415	15	10	8000	8000	7750	7750	7750	-	7750	-	11680	11654	
	TF500	5070	5070	2950	2950	6402	-	6380	6405	1618	-	1640	1615	15	10	8000	8000	7500	7500	7500	-	7500	-	11783	11757	
	TF550	5670	5670	3150	3150	6902	-	6880	6905	1818	-	1840	1815	15	10	7700	7700	7300	7300	7300	-	7300	-	11885	11859	
	TF600	6070	6070	3350	3350	7402	-	7380	7405	2018	-	2040	2015	15	10	7450	7450	7100	7100	7100	-	7100	-	11988	11962	

* Standard

Load Capacity

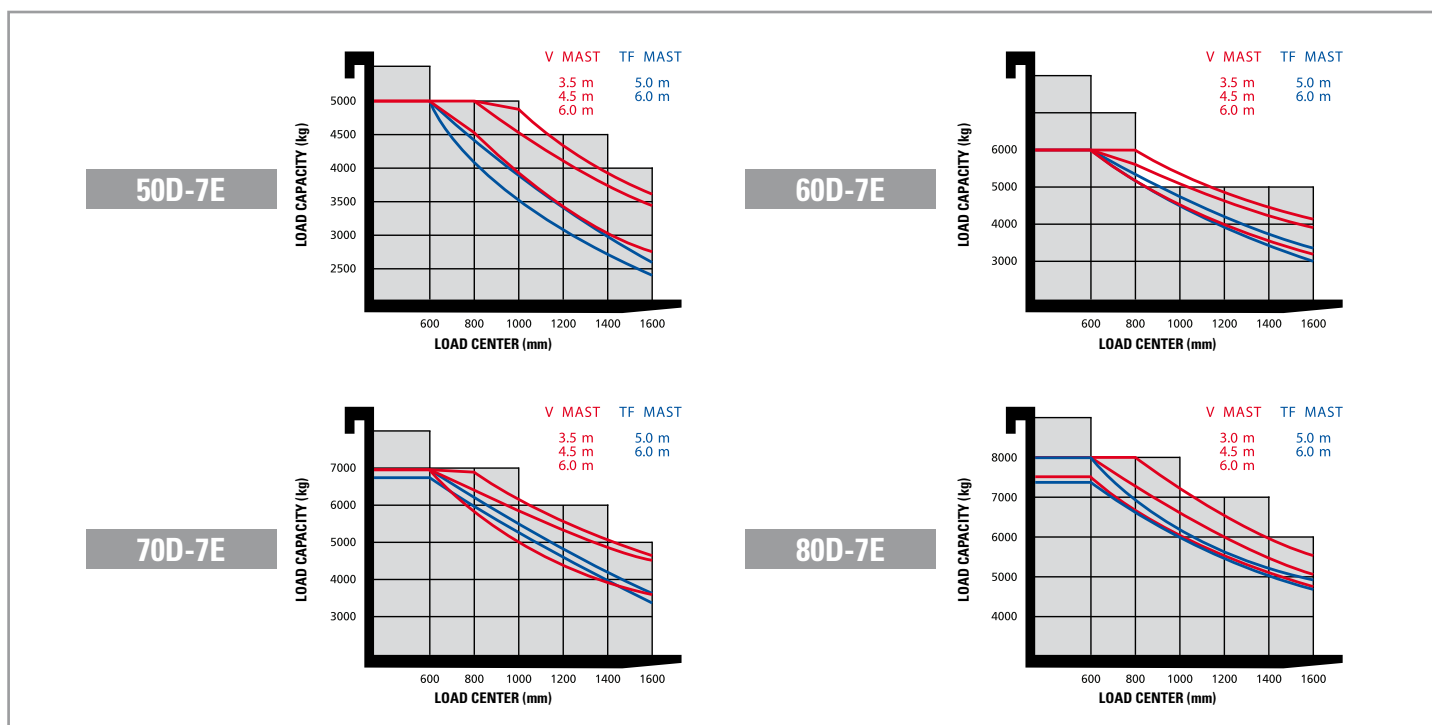

Various Attachments

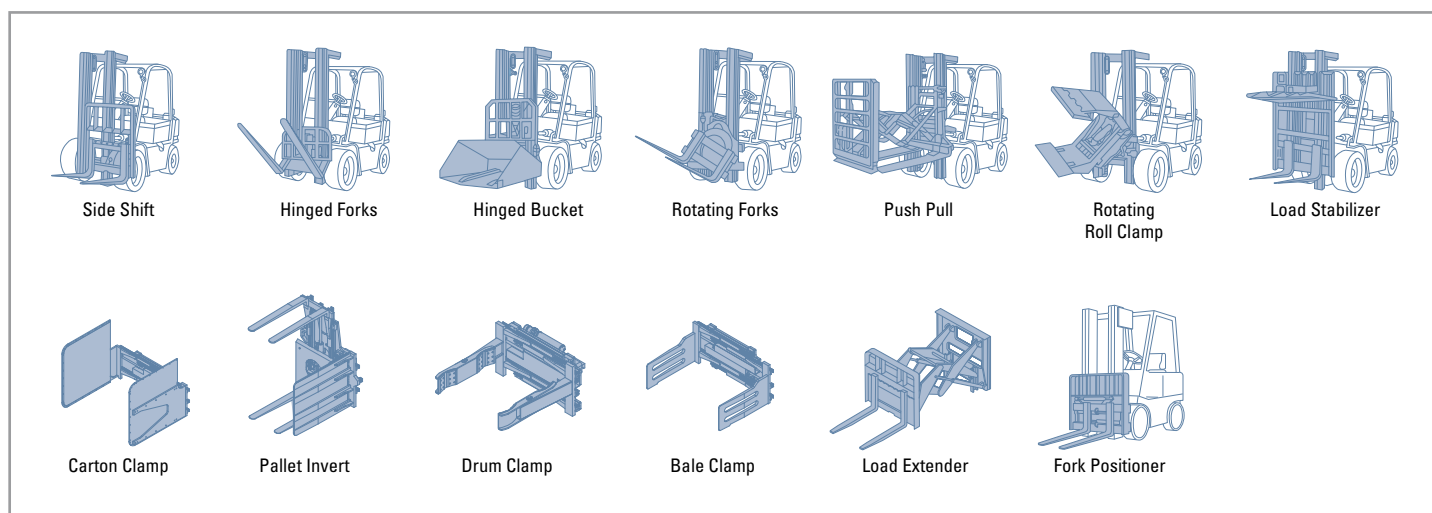

Optional Items

• **FORK (L x W x T) (mm)**

HOOK TYPE

• **50D-7E**

• 1,350 x 150 x 60 · 1,500 x 150 x 60 · 1,800 x 150 x 60
 • 2,000 x 150 x 60 · 2,400 x 150 x 60

• **60/70D-7E**

• 1,350 x 150 x 65 · 1,500 x 150 x 65 · 1,800 x 150 x 65
 • 2,000 x 150 x 65 · 2,400 x 150 x 65

• **80D-7E**

• 1,350 x 180 x 70 · 1,500 x 180 x 70 · 1,800 x 180 x 70
 • 2,000 x 180 x 70 · 2,400 x 180 x 70

SHAFT TYPE

• **50D-7E**

• 1,350 x 150 x 60 · 1,500 x 150 x 60 · 1,800 x 150 x 60
 • 2,000 x 150 x 60 · 2,400 x 150 x 60

• **60/70D-7E**

• 1,350 x 180 x 60 · 1,500 x 180 x 60 · 1,800 x 180 x 60
 • 2,000 x 180 x 60 · 2,400 x 180 x 60

• **80D-7E**

• 1,350 x 180 x 70 · 1,500 x 180 x 70 · 1,800 x 180 x 70
 • 2,000 x 180 x 70 · 2,400 x 180 x 70

• **OVER SHOE** 1,800 / 2,000 / 2,200 / 2,300

• **TIRE SOLID NON-MARKING**

• **SEAT SEATBELT, ARM REST, HIP REST**

• **CABIN & HEATER** CABIN, AIRCON+HEATER

• **MUFFLER** VERTICAL

• **MASTER SWITCH · LICENCE · ELE. BEACON**

• **HAZARD SWITCH**

• **MCV** 3-SPOOL / 4-SPOOL / 5-SPOOL

• **INTEGRAL FORK POSITIONER CARRIAGE**

• **INTEGRAL SIDE SHIFT CARRIAGE**



Notes

A series of horizontal dotted lines for taking notes.

Notes

Lined area for taking notes, consisting of numerous horizontal dotted lines.

Dimensions

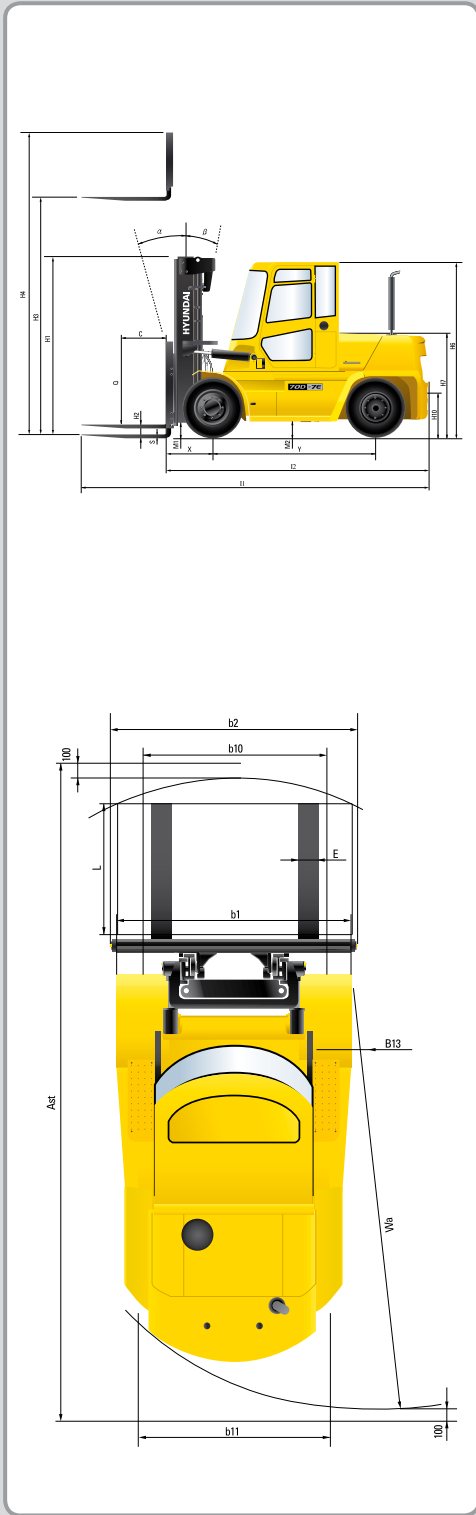

Specifications

Identification

1.1	Manufacturer		Hyundai	Hyundai	Hyundai	Hyundai
1.2	Type		50D-7E	60D-7E	70D-7E	80D-7E
1.3	Drive: electric (battery or mains), diesel, petrol, fuel gas, manual		DIESEL	DIESEL	DIESEL	DIESEL
1.4	Type of operation: hand, pedestrian, standing, seated, order-picker		seated	seated	seated	seated
1.5	Load capacity (standard)	Q (t)	5.0	6.0	7.0	8.0
1.6	Load center distance	c (mm)	600	600	600	600
1.8	Load distance, center of drive axle to forks	x (mm)	605	615	615	690
1.9	Wheelbase	y (mm)	2,300	2,300	2,300	2,500

Weights

2.1	Service weight	kg	8,440	9,245	9,871	19,235
2.2	Axle loading, loaded front/rear	kg	12,046 / 1,556	13,573 / 1,673	14,964 / 1,907	32,199 / 3,036
2.3	Axle loading, unloaded front/rear	kg	4,404 / 4,198	4,403 / 4,842	4,266 / 5,605	9,241 / 9,994

Wheels, chassis

3.1	Tires: solid rubber, superelastic, pneumatic, polyurethane		Pneumatic	Pneumatic	Pneumatic	Pneumatic
3.2	Tires size, front		8.25-15-14	8.25-15-14	8.25-15-14	9.00-20-14
3.3	Tires size, rear		8.25-15-14	8.25-15-14	8.25-15-14	9.00-20-14
3.5	Wheels, number front / rear (X= driven wheels)		4 x / 2	4 x / 2	4 x / 2	4 x / 2
3.6	Track width, front	b10 (mm)	1,580	1,580	1,580	1,632
3.7	Track width, rear	b11 (mm)	1,604	1,604	1,604	1,700

Basic dimensions

4.1	Mast/fork carriage tilt forward/backward	degrees	15 / 10	15 / 10	15 / 10	15 / 10
4.2	Lowered mast height (standard)	h1 (mm)	2,515	2,515	2,515	2,675
4.3	Free lift	h2 (mm)	140	140	140	145
4.4	Lift height (standard)	h3 (mm)	3,030	3,030	3,030	3,040
4.5	Extended mast height (standard)	h4 (mm)	4,275	4,275	4,275	4,375
4.7	Overhead load guard (cab) height	h5 (mm)	2,500	2,500	2,500	2,603
4.8	Seat height / standing height	h7 (mm)	1,395	1,395	1,395	1,464
4.12	Coupling height	h10 (mm)	425	425	425	493
4.19	Overall length	l1 (mm)	4,700	4,765	4,820	5,000
4.20	Length to face of forks	l2 (mm)	3,500	3,570	3,640	3,960
4.21	Overall width	b1 (mm)	2,268 / 2,087	2,268 / 2,087	2,268 / 2,087	2,277
4.22	Fork dimensions LxWxT	l / e / s (mm)	60 x 150 x 1,200	65 x 150 x 1,200	65 x 150 x 1,200	1,200 x 180 x 70
4.23	Fork carriage type		Class IV	Class IV	Class IV	Class IV
4.24	Fork carriage width	b12 (mm)	2,087	2,087	2,087	2,268
4.31	Ground clearance, loaded, under mast	m1 (mm)	195	195	195	250
4.32	Ground clearance, centre of wheelbase	m2 (mm)	220	220	220	287
4.33	Aisle width for pallets 1000 x 1200 crossways (L x W)	Ast (mm)	5,085	5,130	5,175	5,580
4.34	Aisle width for pallets 800 x 1200 lengthways (W x L)	Ast (mm)	5,285	5,330	5,375	5,780
4.35	Turning radius	Wa (mm)	3,270	3,315	3,360	3,690
4.36	Smallest pivot point distance	b13 (mm)	1,190	1,190	1,190	1,354

Performance data

5.1	Travel speed, unloaded	km/h	35.1	34.9	34.8	34.5
5.2	Lift speed, loaded/unloaded	m/s	440 / 460	430 / 460	420 / 460	440 / 480
5.3	Lowering speed, loaded/unloaded	m/s	500 / 450	500 / 450	500 / 450	500 / 450
5.5	Drawbar pull, loaded	N	6,470	6,502	6,527	6,454
5.7	Gradient performance, loaded/unloaded	%	48.3	41.7	37.2	32.9
5.9	Acceleration time, loaded/unloaded (10m)	sec	-	-	-	-
5.10	Service brake		FOOT (Hydraulic)	FOOT (Hydraulic)	FOOT (Hydraulic)	FOOT (Hydraulic)

Engine

6.1	Engine manufacturer / type		HMC D4DD	HMC D4DD	HMC D4DD	HMC D4DD
6.2	Engine power acc. To ISO 1585	kW	73.5	73.5	73.5	73.5
6.3	Rated speed	1/min	2,300	2,300	2,300	2,300
6.4	No. of cylinder / cubic capacity	/cm ³	3,907	3,907	3,907	3,907
6.5	Fuel consumption acc. to VDI cycle	ℓ/h	4.0	4.2	4.5	5.2

Other details

8.1	Type of drive control		Full Auto	Full Auto	Full Auto	Power Shaft
8.2	Operating pressure (attachments)	bar	185	185	185	210
8.3	Hydraulic oil flow (attachments)	ℓ	105	105	105	100
8.4	Sound level at driver's ear according to DIN 12053	db(A)	82	82	82	85

Standard and optional equipment may vary. Contact your Hyundai dealer for more information. The machine may vary according to International standards. All imperial measurements rounded off to the nearest pound or inch.

PLEASE CONTACT

 **HYUNDAI**
HEAVY INDUSTRIES EUROPE
CONSTRUCTION EQUIPMENT

Hyundai Heavy Industries Europe N.V.

VOSSENDAAL 11, 2440 GEEL, BELGIUM TEL: (32) 14-56-2200 FAX: (32) 14-59-3405